

Energy in Iowa

Iowa Association of Naturalists

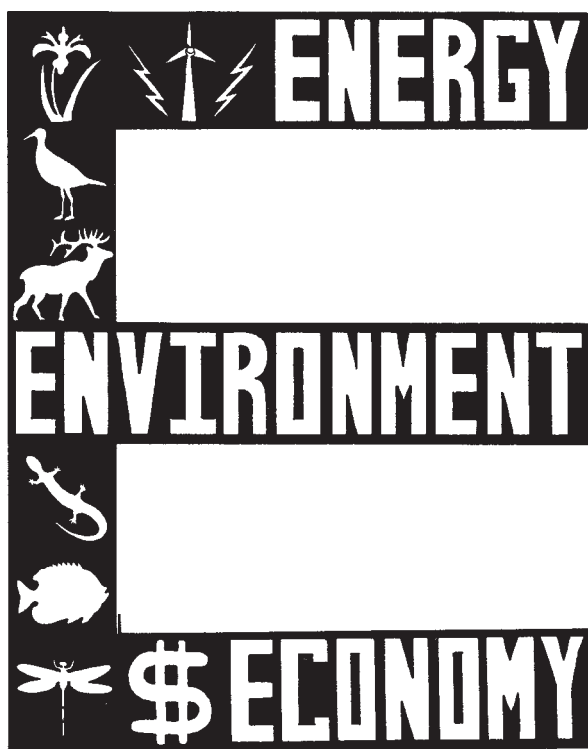

Iowa Environmental Issues Series

Energy in Iowa

Studying energy

The experience of studying energy use in Iowa is like the trick of an optical illusion. At first glance, you see one image. Look harder and you see another image.

At first impression, Iowans' dependence upon nonrenewable fossil fuels seems unchanging. Explore the energy issue further and discover that the 1990 Iowa Energy Efficiency Act set goals to move Iowa off this dependence and into an era that includes a mix of energy strategies.

At first impression, our easy access to energy comes with no strings attached. Explore the issue further and discover how energy choices are connected to environmental and economic factors, as well as state, national, and even international issues.

At first impression, there does not seem to be a groundswell of support for "green" energy. Explore the issue further and discover growing popular support for energy efficiency and renewable fuels.

At first impression, the energy industry may not appear to be building energy efficiency and renewable fuels into their future market strategies. Explore the issue further and discover that some people within the energy industry are investing in a more sustainable energy future.

This booklet is intended to help you see more than first impressions. It's intended to help you see how energy fits into a sustainable future for Iowa. Beginning with an overview of

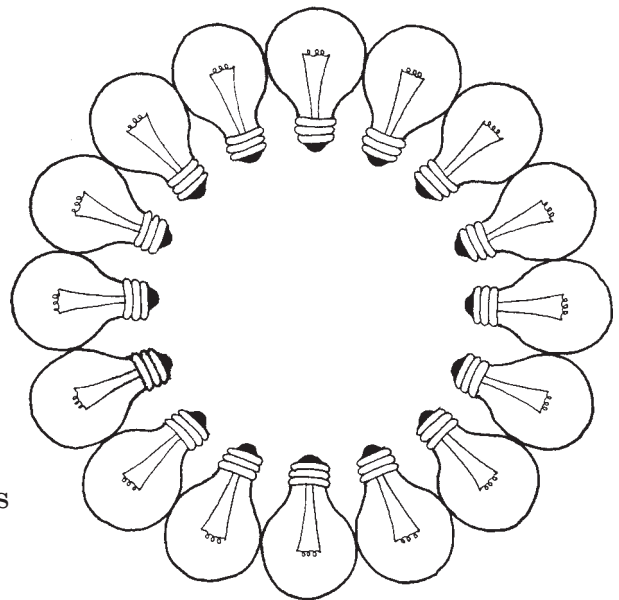

energy use in Iowa, the booklet spotlights the fuels we use and their connections to our environment and economy. We'll look at how Iowans have been addressing energy issues both through legislation and grassroots activism. These various aspects of Iowa's energy picture offer insight to the problems and possibilities for a sustainable energy future.

Know your resources

As we consider sustainable energy use, just what makes one resource more sustainable and another less sustainable? Non-renewable resources exist in fixed amounts. Once they're used up, they're gone. Renewable resources, on the other hand, are materials that can be replenished through natural and human processes.

Fossil fuels are the product of ancient plant and animal remains that accumulated under the Earth's surface. Time, pressure, and heat helped transform this organic matter into either coal or oil and natural gas. The formation of these products took millions of years. Estimates suggest that some fossil fuel supplies will cease to be commercially available beyond the mid-21st century. Oil supplies, for example, are projected to last for another 45 years. Natural gas supplies are projected to last for another 75 years. Coal supplies are expected to outlast both of these, remaining available for several centuries.

Corn, as an example of a renewable resource used for ethanol production, can be replenished in the next growing season. Other renewable resources, such as solar energy, wind, and currents or tides are forces that last forever. Renewable resources may be either those that are replenishable, such as corn, or continual, such as solar energy. In either case, these resources are available for use over and over again.

Environmental and economic impacts are two other features distinguishing sustainable from non-sustainable resources. Those resources that contribute to the long-term stability of a community or region fit the sustainable criteria.

Iowa energy consumption by fuel type

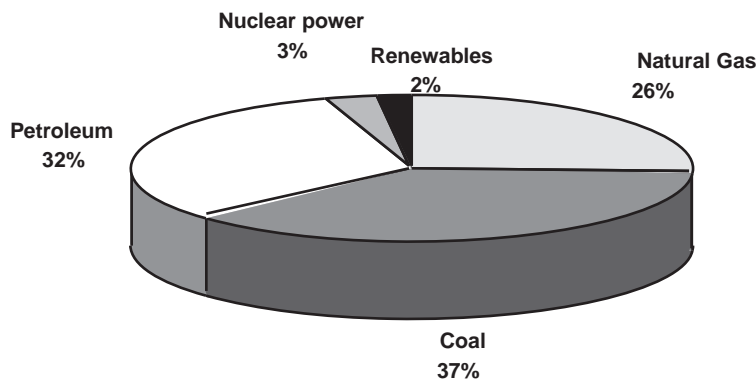

Source: Iowa Department of Natural Resources

Iowa energy use by sector

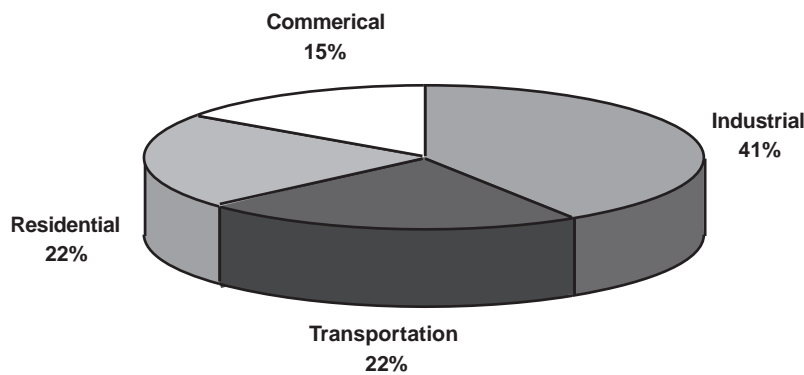

Source: Iowa Department of Natural Resources

The fuels we use

The fuels Iowans use fall into two main categories: **nonrenewable** fossil and nuclear fuels and **renewable** energy resources. The types of nonrenewable fossil fuels consumed in Iowa are coal, petroleum, and natural gas. Water for hydroelectricity, biomass, wind, and solar energy are among the renewable resources being used in the state.

The use of energy can be divided into four sectors:

- Industrial (41 percent) - manufacturing industries, mining, construction, and agriculture
- Transportation (22 percent) - private and public vehicles moving people and commodities
- Residential (22 percent) - private residences, owned or rented
- Commercial (15 percent) - businesses that are not engaged in manufacturing, transportation, or other types of industrial activities

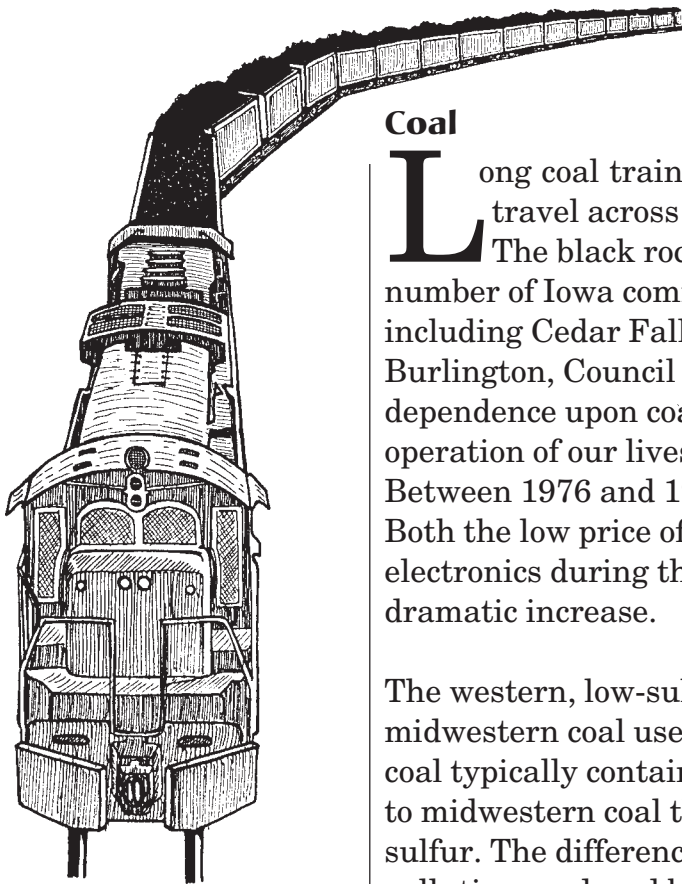

Coal

Long coal trains from Wyoming's Powder River Basin travel across the Great Plains states headed for Iowa. The black rock in those cars will be unloaded in a number of Iowa communities with coal-fired power plants, including Cedar Falls, Pella, Ames, Muscatine, Ottumwa, Burlington, Council Bluffs, Dubuque, and Lansing. Our dependence upon coal-generated electricity for the smooth operation of our lives and businesses has been growing. Between 1976 and 1995, Iowa's coal usage more than doubled. Both the low price of coal and the increase in the use of electronics during this same period of time help explain this dramatic increase.

The western, low-sulfur coal used in Iowa is preferable to the midwestern coal used prior to air pollution concerns. Western coal typically contains less than one percent sulfur compared to midwestern coal that ranges between 1.5 and six percent sulfur. The difference in sulfur content reduces sulfur dioxide pollution produced by burning coal.

Petroleum

Petroleum supplies link Iowa to the international energy scene. Approximately one-half the petroleum consumed in Iowa originates in the Persian Gulf, Venezuela, Mexico, or Norway. The remaining half is produced in the United States.

Crude oil is refined and then piped to Iowa. More than two-thirds of our petroleum is used as gasoline and diesel fuel for ground transportation. The remaining one-third includes liquefied petroleum gas and a variety of products from asphalt to aviation fuel.

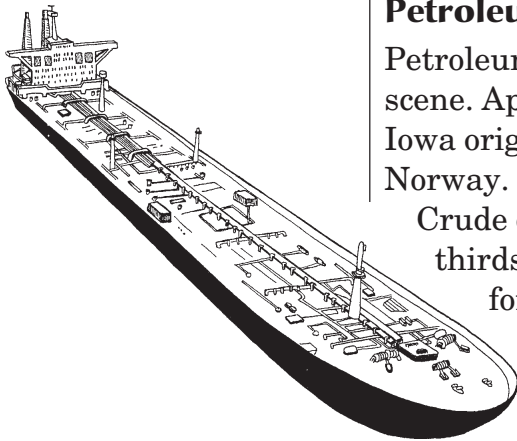

Natural gas

Natural gas comes to Iowa via Oklahoma, Texas, and Canada. Natural gas, our third most common energy source, is used mostly for space and water heating in homes and businesses. Natural gas also is used to make fertilizer products such as anhydrous ammonia.

Nuclear power

The Iowa Department of Natural Resources (DNR) reports nuclear power generation at three percent of Iowa's total energy consumption. Iowa has one nuclear power plant. The Duane Arnold nuclear power plant is located near Palo.

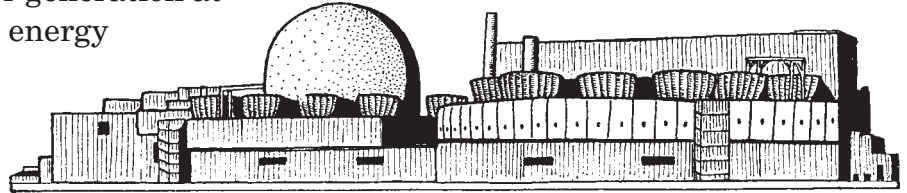

The Duane Arnold nuclear power plant is located near Palo, Iowa.

The renewable energy resources

Here's a look at the four types of renewable energies being developed and harnessed in Iowa.

Hydroelectric

Hydroelectric power —

electricity generated by the action of falling water — historically has been one of the most common renewable resources used by Iowans. Currently, hydropower supplies 1.5 percent of the electricity generated in the state. Based on studies by the DNR, Iowa's estimated hydropower potential is approximately five percent of the states's annual electric usage.

However, cost-effectiveness issues and environmental considerations limit full development of that potential. The use of hydropower is expected to remain stable in the future.

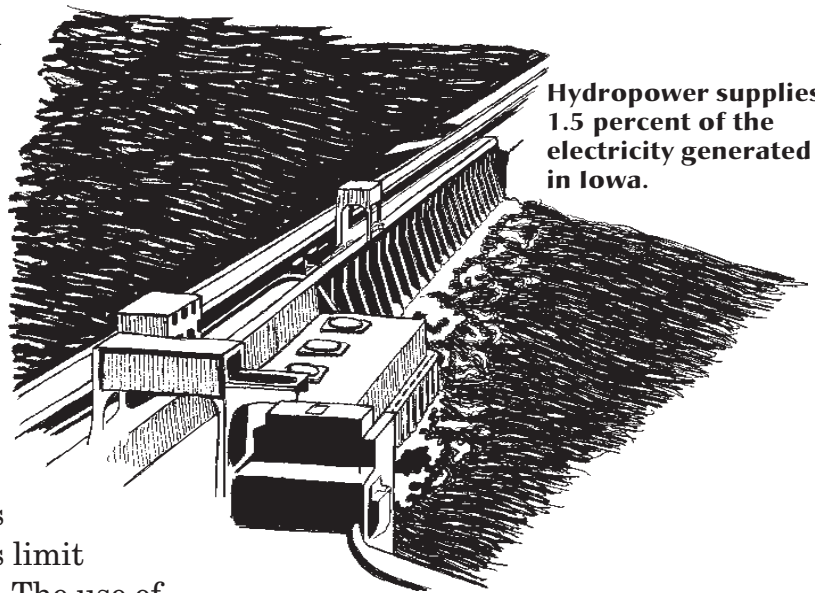

Hydropower supplies 1.5 percent of the electricity generated in Iowa.

Seven hydropower plants operate in Iowa at Iowa Falls, Waverly, Keokuk, Ottumwa, Maquoketa, Amana, and Anamosa. The Keokuk plant, along the Mississippi River, provides the bulk of Iowa’s hydroelectric power. Depending upon the water supply, this facility can produce 135 megawatts — enough electricity to power more than 54,000 homes.

Biomass

Biomass refers to any organic material available on a renewable basis for conversion to electricity or fuel. Corn, switchgrass, wood, and the organic portion of municipal solid waste are biomass materials. Biomass can be converted to usable energy through a number of ways. The three most common methods used in Iowa include direct **combustion** to generate heat, **fermentation** to produce an alcohol such as ethanol, and **anaerobic digestion**. Anaerobic digestion uses bacteria to consume plant or animal matter in an airless environment. The result is the production of methane, a combustible gas. **Gasification**, a fourth method, involves heating materials under controlled conditions to produce combustible gas.

Biomass resources seem logical for Iowa to pursue. Most materials are grown, harvested, stored, and transported through existing infrastructure. These resources can provide a stable, year-round energy supply. Currently, the single most significant biomass by-product used in Iowa is ethanol. However, a variety of biomass resources are being used at numerous locations around the state. Here’s a list of some of the sites burning garbage for electrical generation.

Site	Biomass resource
City of Ames	garbage, sewage sludge for methane gas
Williamsburg	corn cobs
City of Pella	sewage sludge for methane gas
Weiland and Sons Lumber Co., Winthrop, IA	waste wood

Wind

New wind turbines are popping up across Iowa. The familiar old farm windmill harnessed wind to power water pumps and generate electricity on farms in the early 1900s. Rural electrification of the 1930s replaced wind energy with fossil fuel energy. Today, new technology is driving a resurgence of wind power in the state. Through the mid-1990s, medium-sized wind projects began supplying wind-generated electricity to both public and private enterprises. The list includes Spirit Lake and Nevada School Districts, Story County Hospital, a business in Adair, Waverly Light and Power, an apartment complex in West Des Moines, the state fairgrounds, a motel at Boondocks Truck Stop off Interstate 35, and others. Development of utility-scale wind farms continues the momentum. The state's first wind farm operates near Sibley. The wind farm began with five 65 kilowatt (kW) generators and now boasts two 600 kW turbines, with more additions expected in 1998. Future projects are planned near Alta, Algona, and Clear Lake.

By the year 2000, the Iowa Energy Center estimates that approximately 260 utility-scale (more than 100 kW) wind turbines will be operating in Iowa. The towers will generate enough electricity to power an estimated 33,000 homes. According to the Iowa DNR, this would be more than eight times the wind power used in Iowa in 1997.

While Iowa has yet to develop wind resources to the extent that California has, it isn't for lack of potential. Wind energy development in California has had more to do with state energy and tax policies than prime wind resources. The area of best wind, referred to as "the Saudi Arabia of wind energy," lies through much of the upper Midwest, including Iowa. A comprehensive mapping of wind power in Iowa began in 1996

Today, new technology is driving a resurgence of wind power in the state.

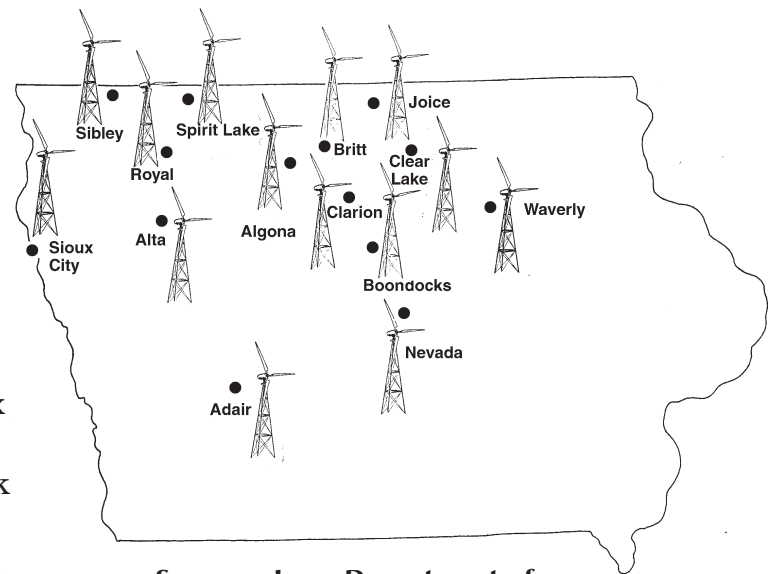

Sources: Iowa Department of Natural Resources (1997)

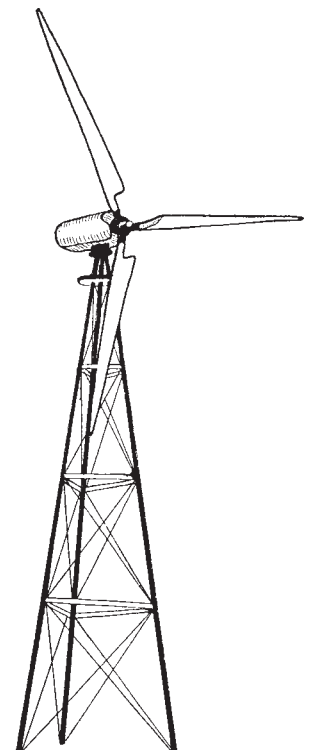

through a project of the Iowa Energy Center and the Iowa Wind Energy Institute. It is the most comprehensive of its kind in the country. Four major wind regions blow across Iowa. The highest wind power area is found in the northwestern corner of the state. The wind classes diminish steadily toward the south and east.

Wind is neither as constant nor as statewide a resource as biomass. The location and season of quality wind will influence how this non-polluting resource will fit into Iowa's integrated energy portfolio.

Four major wind regions blow across Iowa.

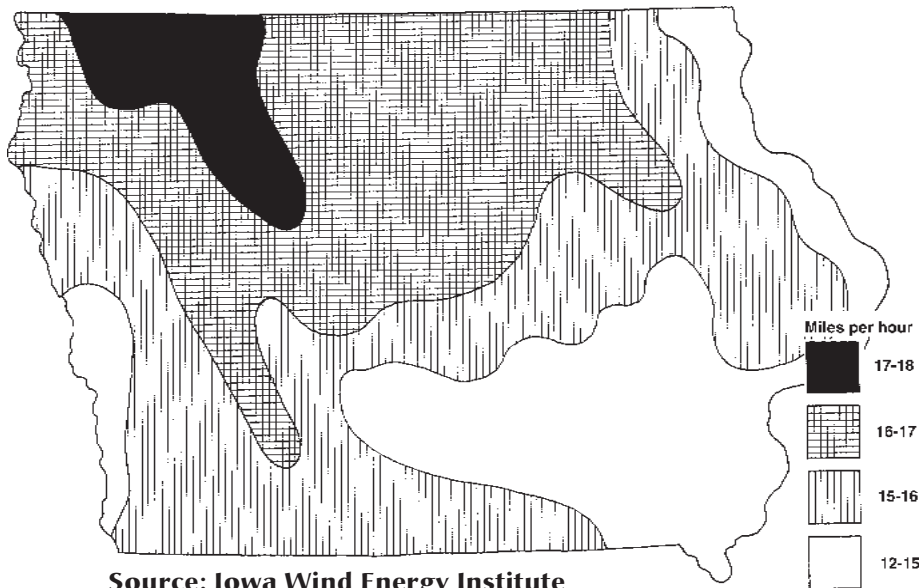

Source: Iowa Wind Energy Institute

Solar

Power derived from the sun is used in Iowa for space and water heating, as well as for photovoltaic electricity. Early solar power efforts involved **active solar** systems. These systems require special equipment to use the sun's energy to heat or cool an existing structure. Water-heating solar panels are an example. Problems with technology, service, and government support caused a shift toward simpler, passive solar systems. **Passive solar** involves designing structures themselves in ways that maximize the use of solar energy for

heating or cooling. Passive solar homes, for example, are built with south-facing windows to capture the low, winter sun and provide shelter from the warm summer sun. Some designs also incorporate heat sinks such as stone or brick floors or walls to maximize the winter warming capacity. The stored solar energy then radiates, warming the building air. There's passive potential on every home's south side.

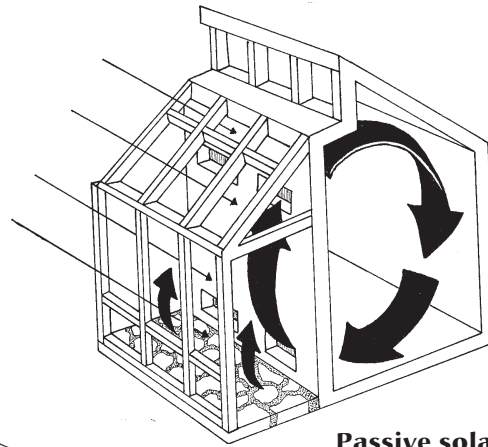

Passive solar homes use structural features such as south-facing windows, a rock patio as a heat sink, and ventilation to maximize the benefit of solar energy.

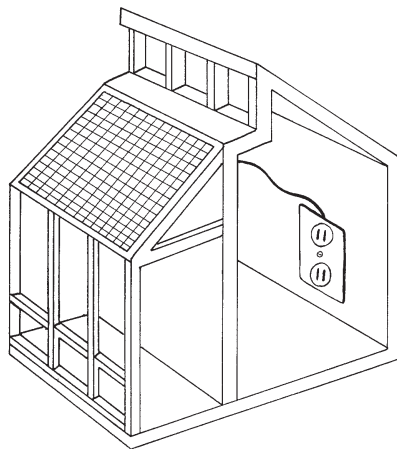

Photovoltaic (PV) cells use microprocessor chips to convert the sun's energy into electricity.

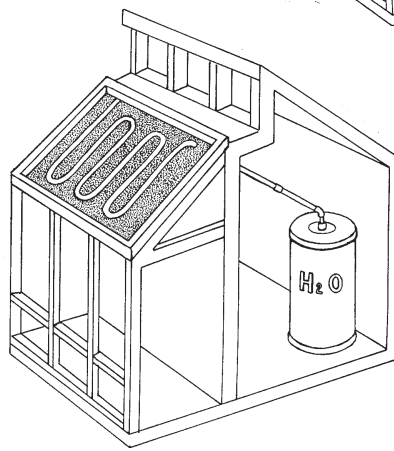

Active solar systems, like this solar water heater, involve the use of special equipment to use the sun's energy.

Photovoltaic (PV) cells, the newest solar technology, use microprocessor chips to convert the sun's light to usable energy without moving parts. Researchers at Iowa State University have placed flexible solar cells on lightweight plastic film. The film is able to power a variety of products from portable radios to space vehicles. Several projects using PV panels were completed in Iowa in 1997, including the installation of 24 PV panels at the Indian Creek Nature Center near Cedar Rapids and a mobile solar demonstration unit of 24 panels built by members of the Iowa Renewable Energy Association (I-Renew).

E: Looking beyond first impressions

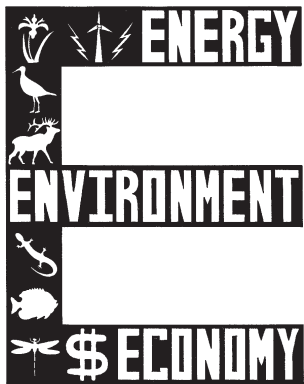

To look beyond first impressions of energy use in Iowa, the link between energy and other issues must be considered. The 1990 Iowa Energy Efficiency Act set the stage for sustainable energy development by incorporating these connections into policy. The law states that Iowa shall meet future energy needs through efficiency “to enhance the economy of the state” and use of renewable resources “that are economically and environmentally viable.” These decision-making criteria represent a departure from the past where economics was the only concern. This energy policy acknowledges the interconnection of both the economic and environmental concerns of energy use.

E: Environmental connections

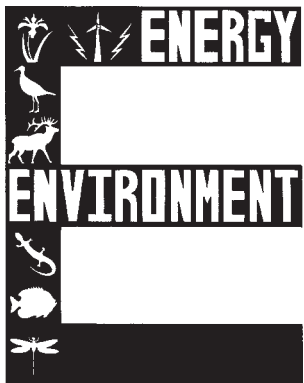

Environmental connections to our energy use involve issues of emission-related air pollution, water quality, urban development, and waste management.

Something's in the air

The story of our fossil fuel dependence spreads far and wide through various combustion-related air pollutants. Greenhouse gases, acid rain, and ground level ozone are generated as by-products of our energy use. The most common emissions include carbon dioxide (CO_2), sulfur dioxide (SO_2), and nitrogen oxides (NO_x).

Certain gases in the atmosphere, called **greenhouse gases**, trap heat. As these gases increase in the atmosphere there is potential for global warming. **Carbon dioxide (CO_2)** is the most prominent greenhouse gas. Forty percent of the total Iowa greenhouse gas emissions come from burning coal.

The remaining greenhouse gas emissions are linked to combustion of petroleum and natural gas in industries, residences, and commercial businesses.

According to the DNR, between 1976 and 1995, Iowa more than doubled its consumption of coal. Consumption of both petroleum and natural gas decreased during this same time period. Reducing coal consumption will have a positive effect on the reduction of Iowa's greenhouse gas emissions.

Sulfur dioxide (SO₂) and **nitrogen oxides (NO_x)** are also produced through the combustion of coal and petroleum. In the atmosphere, these pollutants react with light and water vapor to form sulfuric and nitric acid. Precipitation that forms around these acidic particles is typically known as **acid rain**. The calcium in Iowa soils naturally buffers the effect of acid rain here in this state. However, Minnesota, New England, Canada, and northern Europe have more acid-sensitive soils. These areas are seeing damage to lakes, forests, and agriculture production. This damage has been linked to acid precipitation from midwestern sulfur dioxide emissions.

One more air quality problem is the increase in local ground level ozone, often associated with smog. Although smog is considered a problem primarily for large cities with lots of traffic, Iowa has not been immune to the presence of this pollutant. In 1989 and again in 1992, ground-level ozone exceeded the National Ambient Air Quality Standards in the Davenport area. Smog can contribute to various respiratory difficulties, as well as decreased disease resistance.

Troubled waters

What happens to Iowa's land happens to Iowa's waters. By sheer acreage, Iowa's agricultural economy has an enormous energy-related impact on Iowa waters. Other land uses, including urban development and home lawn care, are equally important contributors. Urban activities cover less acreage, but may have a more intense impact.

The scale of Iowa agriculture, our dependence upon large machinery, energy-intensive livestock production systems, pesticides, and the handling and processing of products all

consume fossil fuels. These practices have a number of consequences for water quality issues in Iowa.

Energy-consumptive tillage practices, particularly in the fall, leave the soil vulnerable to erosion. Soil remains Iowa's number one water pollutant. Washed from fields, soil muddies rivers and lakes, decreasing recreational enjoyment and damaging aquatic habitat.

Natural gas is used to produce commercial nitrogen-based fertilizers. High fertilization rates can lead to heavy nitrate runoff. High levels of nitrates in drinking water can threaten human health. Increased potential for "blue baby" syndrome is one of the most common concerns. Nitrate levels above the maximum level of 45 milligrams per liter can impede an infant's ability to carry adequate oxygen in its bloodstream. Low oxygen levels turns the baby's skin blue. The syndrome is easily corrected once identified, but could be fatal if undiagnosed. Long-term effects of nitrates are less well understood.

Fossil fuel resources are also used to produce petrochemical-based pesticides. Increased use of chemicals over the past several decades has contributed to Iowa's agricultural production, but has also resulted in groundwater contamination due to runoff. Farmers lose millions of dollars annually as pesticides wash out of their fields. Of even greater concern are the long-term health effects on farmers who have worked with these chemicals directly for many years. There is also concern for the long-term, low dosage exposure that comes from contaminated drinking water.

Sustainable agriculture involves practices that reduce the dependence upon off-farm inputs and encourage more environmentally-friendly techniques. The Practical Farmers of Iowa and the Leopold Center for Sustainable Agriculture have been leaders in the sustainable agriculture movement in Iowa. The education, research, and demonstration projects sponsored by these two groups has helped broaden the knowledge and use of practices such as reduced nitrogen application, pastured poultry, and hoop houses for hog production.

Developing new patterns of development

The pattern of development described by the term **urban sprawl** - urban development that spreads laterally into undeveloped areas - builds our fossil fuel dependency right into new communities. One of the most direct energy-related consequences of this type of development is the expanded dependence on automobiles to get from one place to another. With homes distant from shopping centers and places of businesses, the answer has been simply to build more roads for more cars. More cars on more roads results in more fuel to keep those cars running. Fuel has been implicated as both air and water pollutants. Maintaining the urban landscape also has its energy connections. Maintenance of manicured lawns is accomplished with the use of fossil fuel-based fertilizers and pesticides. Urban fertilizer and pesticide use is criticized for its intensity with higher per acre rates than agricultural applications. Because many of the areas being treated are also play areas, children are at greater risk from direct exposure to pesticides in urban settings.

Innovative development that integrates concerns for energy efficiency, the environment, and social dynamics offers a more sustainable pattern for community development. Good examples of such development can be found in the Middleton Hills Project of Middleton Hills, Wisconsin and Prairie Crossings Development of Lake County, Illinois. Statewide newspaper articles in the past few years show increasing concern about the urban sprawl issue in Iowa, and several organizations in Iowa are actively working to address this issue.

What a waste

Coal ash, radioactive waste from nuclear power generators, and our piles of garbage all represent an energy connection to solid waste issues. Special landfills are required for coal ash, and presently there is no adequate long-term disposal method for nuclear waste. Our heaps of garbage represent vast amounts of wasted resources and energy. Alternative energy, recycling, and other waste management strategies offer a better way to reduce waste and save energy. The Ames

A beverage can produced using recycled aluminum saves 96 percent of the energy required when using new aluminum.

municipal power plant, for example, burns garbage along with coal. Garbage is sorted both for recyclable and noncombustible materials prior to burning. The use of the remaining,

combustible garbage as a fuel helps reduce the plant's dependency on coal.

Crane-Washington recovers through TAA

Crane-Washington, a foundry facility in Washington, Iowa (pop. 6,700) found itself on the verge of closing in the early 1990s. Since 1968, Crane-Washington had enjoyed profitable operations. But international competition intensified in the next two decades. Working with Iowa Electric Service (IES), Crane-Washington participated in the first Total Assessment Audit (TAA) in Iowa and the nation.

The commitment to improving efficiencies and reducing costs involved self-investment throughout Crane-Washington operations. Direct energy savings of 29 percent in kilowatt hours per ton of melted metal were achieved. These and other savings have combined to revive Crane-Washington into a competitive and healthy Iowa business.

Iowa businesses can't afford to waste valuable resources and expect to remain competitive. Comprehensive energy audits known as Total

Assessment Audits (TAA) help industries and businesses increase profitability. TAAs recognize the energy link to solid waste and scrutinize it as an important part of the overall assessment.

E: Economic Connections

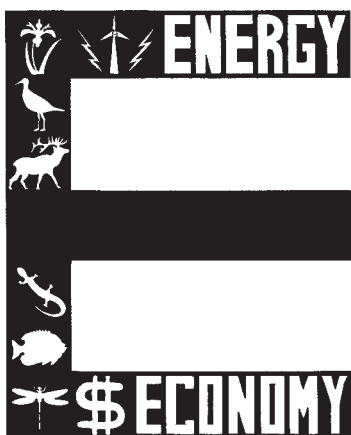

Some economic development models use the image of a bucket to represent the health of the economy. Different strategies can be used to fill the bucket. However, these efforts are often undermined if the bucket leaks. The majority of energy resources we use to drive our economic activity are non-renewable. So while our economy may be growing, we are exporting — or leaking — significant energy dollars. According to the DNR, Iowa's energy bill was \$5.9 billion in 1994. Two-thirds of that, or \$3.9 billion, flows out of Iowa to support economies out of state. A model of the economy developed by the Regional Economic Modeling

Institute indicates money spent on energy efficiency measures stay in the state longer than money spent importing coal and petroleum.

Our dependence upon fossil fuels makes our economy vulnerable to energy price swings that result from sensitive politics with oil-producing countries. The DNR's 1996 Energy Plan Update reported the clear connections between energy costs, economic output, and unemployment in Iowa. High energy prices in the early 1980s contributed to reduced economic output and high unemployment. Lower energy prices in the late 1980s and early 1990s helped reverse those trends. Compliance with the Clean Air Act and efforts to address global warming concerns may result in higher energy costs in the future. The coexisting relationship between energy price and economic output is important to note.

Inefficient use of energy creates another leak in the economic bucket. This leak can be plugged more easily. Poorly insulated walls, doorways, and windows allow valuable energy dollars to escape. This problem often affects low-income Iowans the most.

Not all energy use is bad. In fact, energy resources that power Iowa's economy make it possible for us all to live here. But what resources we use and how we use them does impact our economic, social, and environmental health. Highlighting the link between energy, the environment, and our economy reveals a clearer picture of energy in Iowa. A broader energy portfolio will contribute not only to the health of Iowa's environment, but will help bring long-term stability to our economy. A 1997 study of ethanol, for example, attributes 42,000 jobs, \$1.5 billion in economic activity, and \$111 million in increased tax revenue to the development of ethanol in

Our dependence on fossil fuels allows money to drain out of our state's economy.

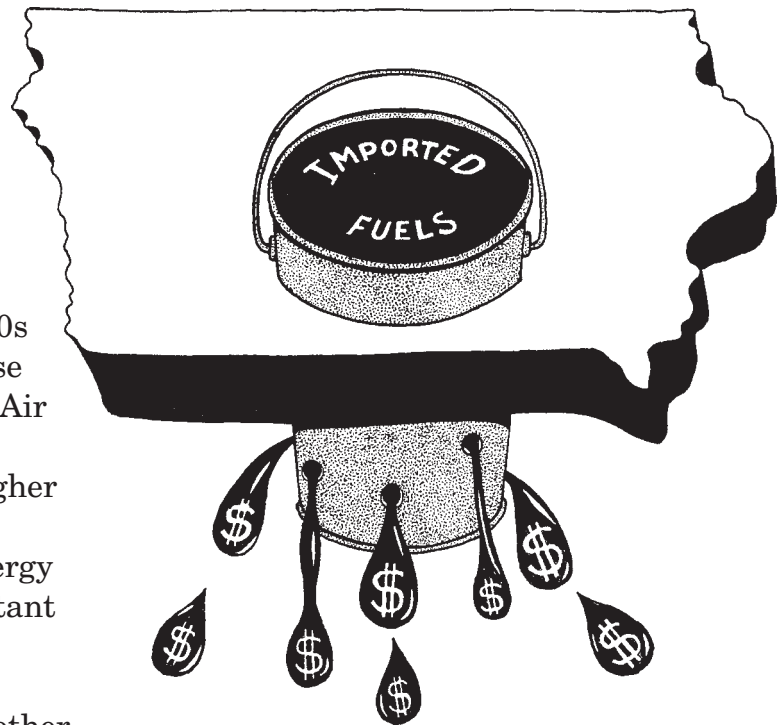

Iowa. To better understand the dynamics of these connections is to reveal new possibilities. Paul Hawken's book *The Ecology of Commerce* argues that real potential awaits us in innovative solving ecological and economic issues simultaneously.

Revisiting Iowa's energy vision

A commitment to exploring the possibilities of sustainable energy use in Iowa is found in state and federal legislation, as well as individual, business, and organization actions.

The energy crisis of the mid-1970s motivated both state and federal legislators to initiate energy efficiency and alternative energy measures. These measures have been built upon in recent years. At the same time, citizens have become better able to respond to environmental issues.

Legislation leading the way

The 1983 Iowa Alternative Energy Production (AEP) law mandates that utilities purchase 105 megawatts (MW) from alternative sources. This requirement is approximately one percent of Iowa's annual energy demand.

Progress on meeting the AEP mandate was slow for its first 13 years, but finally reached implementation in 1997. As of 1996, utilities had contracted for just 15 percent of the required megawatts. Most of the contracts involved biomass supplies, with only a small percentage coming from wind projects. In April 1997, however, a breakthrough came with the announcement of a wind farm in Buena Vista and Cherokee counties. A total of 253 wind turbines, stretching over 40 sections of land, are projected to be operational by

mid-1999. The project will generate construction jobs, turbine maintenance jobs, construction materials, and farmland leases all pumping vital dollars into the local economy. Electricity generated through this wind project also will have the added benefit of reducing carbon dioxide and sulfur dioxide emissions. The project is an important step toward taking alternative energy resources seriously — something that might not have happened without AEP legislation.

The 1990 Iowa Energy Efficiency Act took energy policy a step further. This law called for future energy needs to be met through the combined strategies of energy efficiency and renewable energy. The law set two goals: to meet future energy demands by increasing energy efficiency rather than supply and to increase the use of alternative energy resources from two percent of Iowa's consumption to ten percent by the year 2015.

The 1992 federal Energy Policy Act (EPACT) has restructured the way the natural gas industry functions. Changes in the electric utility industry are soon to follow. The restructuring in both industries has potential to profoundly affect all of the goals set out in the 1990 Energy Efficiency Act.

Electric utility restructuring explained

Currently, the electric utility that maintains power lines to your home, school, or business is also the utility that supplies the electricity. Your choice of companies is restricted to the server in your area. Proposals for restructuring or deregulating the electric utility industry would allow you to purchase electric power from the company of your choice. The power would be delivered to the distribution grid that is connected to your home, school, or business. The grid owner, therefore, could supply everything but the electricity itself, including use of the grid and other services, such as metering and billing.

Advocates hail the increased opportunity for competition, projected reduced electricity costs, and increased services offered. The pressure to increase efficient use of existing power plants is expected by some to defer the need for new, expensive plant construction. Another perspective, however, cautions that only larger customers will reap the benefits and smaller customers will end up paying higher bills. There are concerns about which customers will get priority service when outages occur and whether utility companies will continue to view investing in social programs such as low-income energy-assistance programs to be to their competitive advantage. At this writing, there are many questions and few answers. Each state has the opportunity to decide independently how to handle deregulation. It is possible, however, that the federal government may enter the debate.

Walking the talk

Iowa's energy vision is more than a paper statement. A broad spectrum of Iowans are actively engaged in making Iowa's sustainable energy future a reality. Plug in here to some of the action made possible by individuals, government programs, and utility leadership.

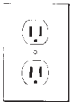

Curriculum catalyzes community activism

In 1992, Hector Ibarra, a sixth-grade science teacher in West Branch, developed an innovative sustainable energy curriculum "Partners in Environmental Science: Investing in Our Future." It has made powerful connections between students, energy conservation, and the community. Classroom lessons involved families, school officials, other students, and local businesses making improvements around the community. Between 1992 and 1996, 250 of West Branch's 700 households were involved in home improvement projects. When student research indicated the need for more efficient lighting in the school, a new lighting system was installed in 1995. Negotiations for the project involved students, school officials, and a local bank. Energy savings from this retrofitting alone have totaled approximately \$200 per month. Skills and knowledge gained from the experiences have taught valuable lessons about how community leadership and environmental issues go hand-in-hand.

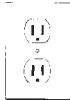

Renewable energy taking root

The Iowa Renewable Energy Association (I-Renew) offers grassroots involvement for more than 1,100 individuals and businesses dedicated to promoting sustainable energy use. Founded in 1992, I-Renew helps gather and distribute information about renewable energy and conservation and encourages retail opportunities. Its annual Energy Expo and Alternate Fuel Vehicle Showcase has become one of I-Renew's major projects. I-Renew also produces a quarterly newsletter and a Sustainable Energy Sourcebook.

- I-Renew has been active in the Iowa Sustainable Energy for Economic Development
- (SEED) coalition has been active in legislative initiatives concerning energy issues.

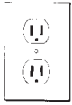

DNR sampler

The DNR Energy Bureau's mission is to "assist Iowans to adopt energy efficiency and to use renewable energy resources by partnering with utilities, federal government, public associations, financiers, and others. The Bureau works to implement all energy projects which are both environmentally and economically sound." In order to accomplish this mission, the Bureau has established dozens of programs that further the effective use of energy while realizing economic opportunities. Examples include: the Iowa Energy Bank program, which implements energy improvements for schools, hospitals, and other non-profits, marketing and promotion of biomass fuels such as ethanol, switchgrass, and methane, and agricultural energy management. The DNR also is responsible for energy emergency preparedness and tracking energy consumption data for the state.

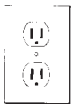

Keeping Iowa centered on energy

Created as part of the 1990 Iowa Energy Efficiency Act, the Iowa Energy Center's research, demonstration, and education projects are dedicated to increasing Iowa's energy efficiency and use of alternative energy. The Energy Resource Station (ERS), located on the Des Moines Area Community College campus in Ankeny, is the shining star of the center's efficiency programs. This unique facility tests and demonstrates all HVAC (heating, ventilation, and air conditioning) components in a building at the same time. This facility meets the needs of architects, engineers, contractors, and building managers faced with a burgeoning variety of new energy-efficient products. The center's Alternative Energy Revolving Loan Program and research on biomass and wind are particularly noteworthy. Education and demonstration projects help the center disseminate important energy information, reaching audiences ranging from industry leaders to school students to nature center visitors. The Iowa Energy Center projects will continue to keep Iowa centered on its energy vision.

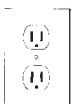

On the edge of new wind

A bold move by Waverly Light and Power, a municipal utility, in 1993 has helped pave the way for wind projects in Iowa and the Midwest. Looking to broaden their energy resource base, the utility began to invest in wind energy despite the skepticism of peers. Their first step was to conduct a feasibility study to determine the wind potential near Waverly. Results indicated a viable wind resource, and the first utility-owned turbine in the Midwest was soon installed. The 80-kilowatt turbine remains a modest symbol of the cutting edge work

Waverly Light and Power has done, and the feasibility study has since served as the foundation of nearly every other wind project in Iowa. The utility has continued to be a leader by sharing its experiences with other utilities in Iowa and throughout the Midwest. Waverly Light and Power has been recognized both in Iowa and nationally for its role in wind systems development.

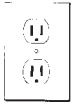

Problem solving together

The Iowa Agricultural-Energy-Environmental (AEE) Initiative was a cooperative program of the Iowa Department of Agriculture and Land Stewardship, Iowa State University, the University of Iowa, Practical Farmers of Iowa, the DNR, and farmers in all 99 counties. The AEE, which ended in 1996 due to discontinued funding, sponsored programs aimed at conserving energy, preventing groundwater pollution, and reducing farmers' production costs by reducing the use of agricultural chemicals. Between 1988 and 1994, this program helped lower nitrogen fertilizer use by 1.6 billion pounds, reduced energy consumption by 500 million gallons of diesel fuel, and saved \$300 million.

Are we all in step?

Diverse and exciting projects are in place, numerous Iowans are embracing new opportunities to use energy more sustainably, and Iowa has a solid foundation in its 1990 Energy Efficiency Act. However, there are many different steps to this energy dance.

Some utility watchers express concern about the impact of the electric utility restructuring. Legislative initiatives by utilities, in both 1995 and 1996, attempted to modify or repeal the entire 1983 Alternative Energy Production Act. In 1996, with national trends toward deregulation, utilities argued that energy efficiency and renewable energy resources would hamper their ability to compete. There's concern by others, that as competition increases between utilities, short-term gains may take precedence over long-term planning.

At the same time, utility strategies are influenced by their sense of consumer preference. Energy bills have remained fairly stable for a number of years and energy remains a low-priority issue in the eyes of many. Public support for sustainable energy reported by a 1996 national poll has had little opportunity to exercise itself through actual energy purchases, and utilities remain skeptical.

Excerpts from “America Speaks Out on Energy” Poll (from the in I-Renew Winter 1997 newsletter)

A national poll taken in late 1996, “America Speaks Out on Energy: A survey of 1996 post-election views,” reports broad public support for renewable energy and energy efficiency technology programs. The poll, conducted by the Sustainable Energy Coalition, found broad, bipartisan support for federal funding and programs to support these measures. Here are findings of the poll:

- 52 percent support tax incentives for either renewable energy or energy efficiency efforts
- 83 percent prefer redirecting tax breaks to renewable fuels
- 69 percent favor requiring utilities to invest in energy efficiency programs
- 71 percent view global climate change as a serious threat, and this view extends across all political parties

Toward a sustainable energy future

It's clear that current energy use in Iowa has direct impacts on both our economy and environment. It's also clear we have options that can help Iowa embrace the future optimistically. The goals laid out in Iowa's 1990 Energy Efficiency Act present a valuable guide for both state policy and individual action. The important connections made in this legislation influence how we think about and plan for energy use in Iowa. For that future to be sustainable, energy choices must reflect environmental and economic connections.

As individuals, we can strive for improved energy efficiency at home, school, and work by:

- turning off lights and appliances when we're done using them
- plugging air leaks around windows and doors
- improving insulation in walls and attics
- purchasing energy efficient products
- taking advantage of energy audit services from utility companies
- busing, carpooling, biking, or walking whenever possible

Individuals can also support the integration of alternative energy in the state's energy portfolio by:

- supporting legislation that furthers the development of renewable energy
- researching renewable energy investments of local utility companies
 - communicating with utility companies about your financial support for renewable energy

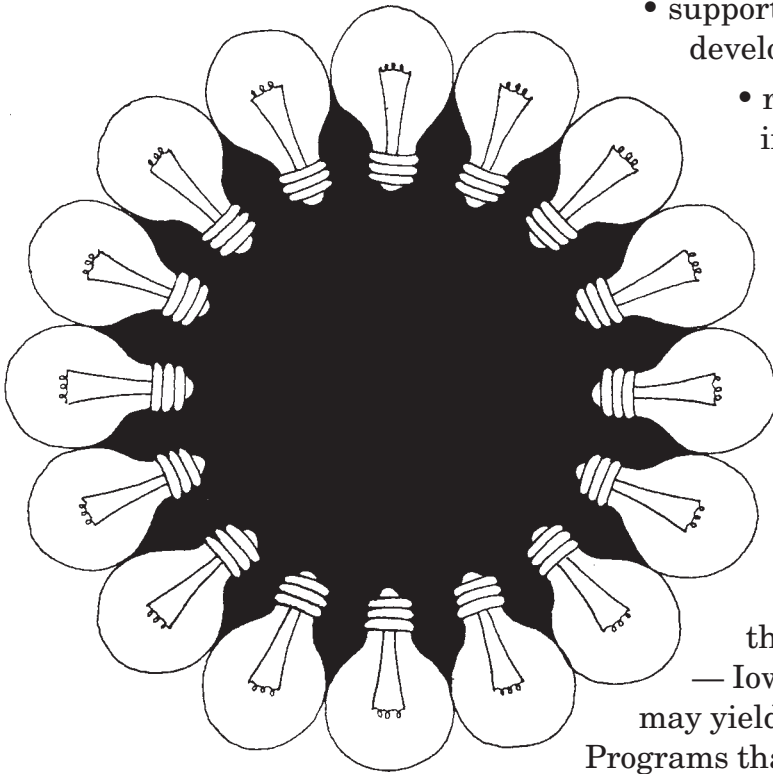

These actions apply to individuals, businesses, government, and non-profit organizations alike.

Current programs that focus on the commercial and industrial sector — Iowa's largest energy consumers — may yield the greatest energy savings.

Programs that focus on individual action may yield less in overall energy savings, but can help

foster an engaged citizenry - one important ingredient for moving forward with energy goals.

Our ability to look beyond first impressions and toward a sustainable energy future will depend upon diverse forces

working together, asking critical questions about how best we can use our resources to meet our needs, and daring to take bold steps.

Useful resources

Agencies

Iowa Department of Natural Resources: Energy Bureau

Wallace State Office Building

Des Moines, IA 50319

Phone: 515/281-8681

Specific resources: **1998 Energy Plan Update** and *Energy Bulletin* newsletter

Iowa Energy Center;

2521 Elwood Dr., Suite 124

Ames, IA 50010

Phone: 515/294-8819

Specific resources: **Home Series, comprehensive wind maps, Energy Resource Station** (located in Ankeny), *Perspectives* newsletter

Iowa Renewable Energy Association

P.O. Box 2132

Iowa City, IA 52244-2132;

Phone: 319/338-3200; E-mail: irenew@igc.apc.org

Specific resource: *Energy Matters* newsletter

Center for Energy and Environmental Education: University of Northern Iowa

Cedar Falls, IA 50614-0294

Phone: 319/273-2573

Specific resource: **CEEE News**

Additional Information

Homemade Money; Richard Heede and staff of Rocky Mountain Institute; Brick House Publishing, Amherst, NH: 1995.

Web Sites

Iowa Energy Center

<http://www.energy.iastate.edu>

Iowa Energy Center homepage

The Energy Efficiency and Renewable Energy Network (EREN)

<http://www.eren.doe.gov>

Comprehensive information program of the U.S. Department of Energy

RENEW America

http://www.crest.org/sustainable/renew_america

A network of groups and leaders exchanging ideas and expertise for improving the environment

Notes

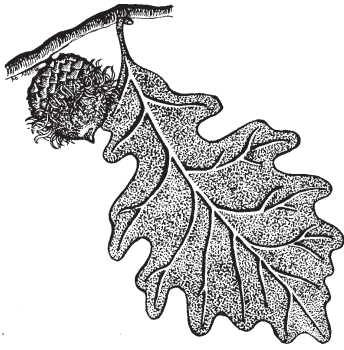

Iowa Association of Naturalists

The Iowa Association of Naturalists (IAN) is a nonprofit organization of people interested in promoting the development of skills and education within the art of interpreting the natural and cultural environment. IAN was founded in 1978 and may be contacted by writing the Conservation Education Center, 2473 160th Rd., Guthrie Center, IA 50115, 515/747-8383.

Iowa Environmental Issues Series

In order to make wise decisions, people need a basic understanding of the factors involved in current environmental issues. They need to understand how their lifestyle is tied to these issues and how changes in lifestyle can impact the environment. The Iowa Association of Naturalists has created this series of booklets to offer a basic understandable overview of Iowa environmental issues. These booklets will assist educators in teaching students about topics that affect the Iowa environment. The seven booklets in this series are:

- Iowa Habitat Loss and Disappearing Wildlife (IAN-101)
- Iowa Air Pollution (IAN-102)
- Iowa Water Pollution (IAN-103)
- Iowa Agricultural Practices and the Environment (IAN-104)
- People, Communities, and Their Iowa Environment (IAN-105)
- Energy In Iowa (IAN-106)
- Iowa Waste Management (IAN-107)



Energy In Iowa was published by IAN with major funding from the Iowa Energy Center. Other booklets in the *Iowa Environmental Issues Series* were published by IAN with major funding from the REAP Conservation Education Board (September 1998).



Review Committee

- Cele Burnett, Consultant, E Resources Group, Inc.
- Dan Cohen, Naturalist, Buchanan County Conservation Board
- Detra Dettmann-Easler, Camp and Program Director, Louisa County Conservation Board
- Jean Eells, Consultant, E Resources Group, Inc.
- Judy Levings, State 4-H Youth Development Specialist, Iowa State University
- Jim Pease, Extension Wildlife Specialist, Iowa State University
- Diane Pixler, Naturalist, Marshall County Conservation Board
- A. Jay Winter, Training Officer, Iowa Department of Natural Resources

Editorial Board

- Text: Jan Libbey
- Illustrations: Mark Müller
- Design and Layout: Ames Best Communications
- Published by: Iowa Association of Naturalists

Energy In Iowa is one in a series of six booklets that are part of the *Iowa Environmental Issues Series*. The booklets in the series include:

Iowa Environmental Issues

Iowa Habitat Loss and Disappearing Wildlife	(IAN-101)
Iowa Air Pollution	(IAN-102)
Iowa Water Pollution	(IAN-103)
Iowa Agricultural Practices and the Environment	(IAN-104)
People, Communities, and Their Iowa Environment	(IAN-105)
Energy In Iowa	(IAN-106)
Iowa Waste Management	(IAN-107)

The Iowa Association of Naturalists also has produced five other booklet series that provide readers with a clear, understandable overview of topics concerning the Iowa environment and conservation. The booklets included in each of the other five series are listed below.

Iowa Wildlife Series

Iowa Mammals	(IAN-601)
Iowa Winter Birds	(IAN-602)
Iowa Nesting Birds	(IAN-603)
Iowa Reptiles and Amphibians	(IAN-604)
Iowa Fish	(IAN-605)
Iowa Insects and Other Invertebrates	(IAN-606)

Iowa's Natural Resource Heritage

Changing Land Use and Values	(IAN 501)
Famous Iowa Conservationists	(IAN 502)
Iowa's Environmental Laws	(IAN 503)

Iowa Wildlife and People

Iowa Wildlife Management	(IAN-401)
Keeping Iowa Wildlife Wild	(IAN-402)
Misconceptions About Iowa Wildlife	(IAN-403)
State Symbols of Iowa	(IAN-404)
Iowa Food Webs and Other Interrelationships	(IAN-405)
Natural Cycles In Iowa	(IAN-406)
Iowa Biodiversity	(IAN-407)
Adapting To Iowa	(IAN-408)

Iowa Plants

Iowa's Spring Wildflowers	(IAN-301)
Iowa's Summer and Fall Wildflowers	(IAN-302)
Benefits and Dangers of Iowa Plants	(IAN-303)
Iowa's Trees	(IAN-304)
Seeds, Nuts, and Fruits of Iowa Plants	(IAN-305)
Iowa's Mushrooms and Other Nonflowering Plants	(IAN-306)
Iowa's Shrubs and Vines	(IAN-307)

Iowa's Biological Communities

Iowa's Biological Communities	(IAN-201)
Iowa Woodlands	(IAN-202)
Iowa Prairies	(IAN-203)
Iowa Wetlands	(IAN-204)
Iowa Waterways	(IAN-205)

These booklets are available to download via PDF on the ISU Extension Store:

store.extension.iastate.edu

This publication is printed on recycled paper.

